

HORIZONTAL & VERTICAL CONTROL FOR LUBBOCK, TEXAS JANUARY, 2000

HORIZONTAL DATUM NAD83 VERTICAL DATUM NAVD 88

PT NO	NORTHING	EASTING	ELEVATION	WGS84 LAT	WGS84 LONG	ELLIP HGHT
1024	7271996.925	894577.054	3320.01	33°34'10.39713"N	102°01'35.13684"W	3234.12

HORIZONTAL DATUM NAD27 VERTICAL DATUM NGVD 29

PT NO	NORTHING	EASTING	ELEVATION	WGS84 LAT	WGS84 LONG	ELLIP HGHT
1024	721946.019	621815.197	3318.76	33°34'10.39713"N	102°01'35.13684"W	3234.12

POINT DESCRIPTION

80d NAIL

**U
S
G
S**

**Q
U
A
D**

**M
A
P
N
U
M
B
E
R**

**W
O
L
F
F
O
R
T
H**

**P
O
I
N
T**

**N
U
M
B
E
R**

**1
0
2
4**

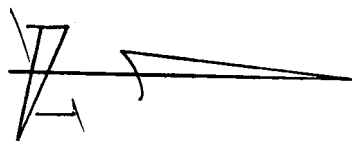
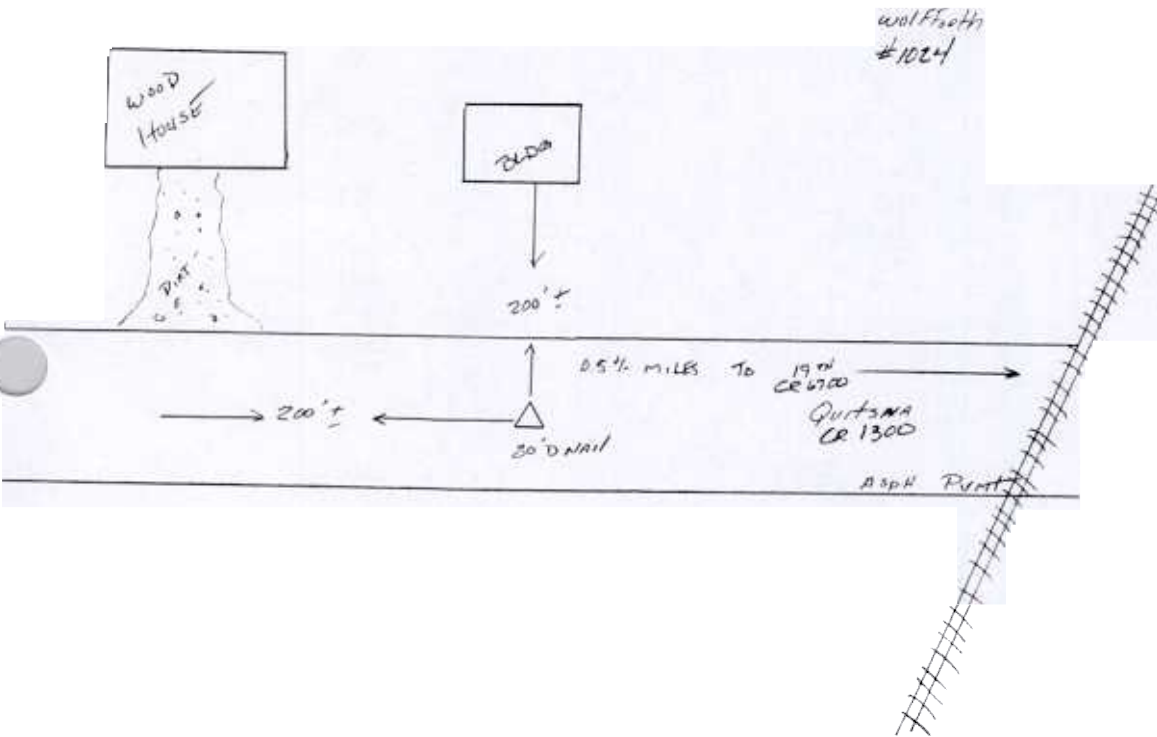

HORIZONTAL & VERTICAL CONTROL FOR LUBBOCK, TEXAS JANUARY, 2000

HORIZONTAL DATUM NAD83 VERTICAL DATUM NAVD 88

PT NO	NORTHING	EASTING	ELEVATION	WGS84 LAT	WGS84 LONG	ELLIP HGHT
1025	7274969.932	894622.775	3315.84	33°34'39.81053"N	102°01'35.77597"W	3229.90

HORIZONTAL DATUM NAD27 VERTICAL DATUM NGVD 29

PT NO	NORTHING	EASTING	ELEVATION	WGS84 LAT	WGS84 LONG	ELLIP HGHT
1025	724918.419	621889.261	3314.58	33°34'39.81053"N	102°01'35.77597"W	3229.90

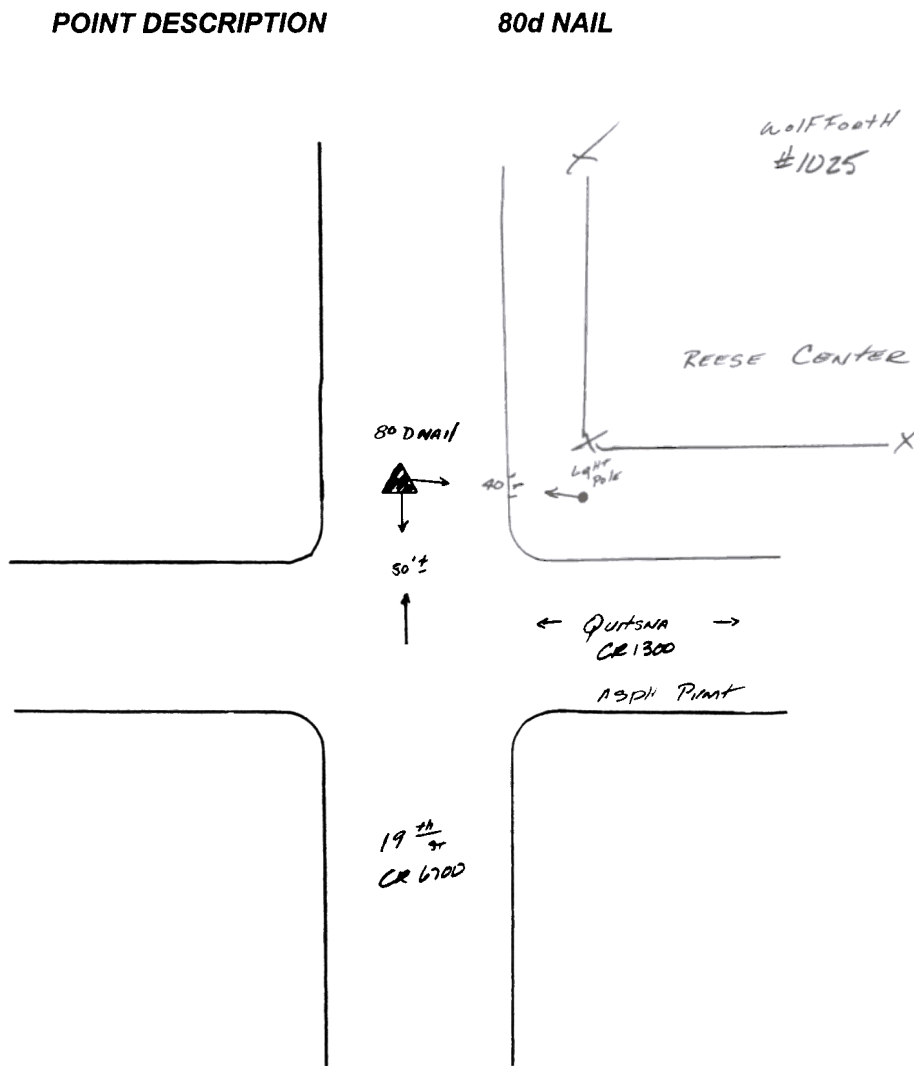

U
S
S

 Q
U
A
D

 M
A
P

 W
O
L
F
F
O
R
T
H

 P
O
I
N
T

 N
U
M
B
E
R

 1
0
2
5

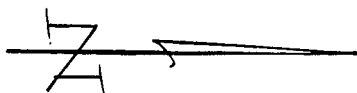

**HORIZONTAL & VERTICAL CONTROL FOR
LUBBOCK, TEXAS
JANUARY, 2000**

HORIZONTAL DATUM NAD83 VERTICAL DATUM NAVD 88

PT NO	NORTHING	EASTING	ELEVATION	WGS84 LAT	WGS84 LONG	ELLIP HGHT
1026	7277038.477	894738.516	3310.30	33°35'00.30347"N	102°01'35.22915"W	3224.32

HORIZONTAL DATUM NAD27 VERTICAL DATUM NGVD 29

PT NO	NORTHING	EASTING	ELEVATION	WGS84 LAT	WGS84 LONG	ELLIP HGHT
1026	726985.743	622024.718	3309.04	33°35'00.30347"N	102°01'35.22915"W	3224.32

POINT DESCRIPTION

80d NAIL

*WolfForth
#1026*

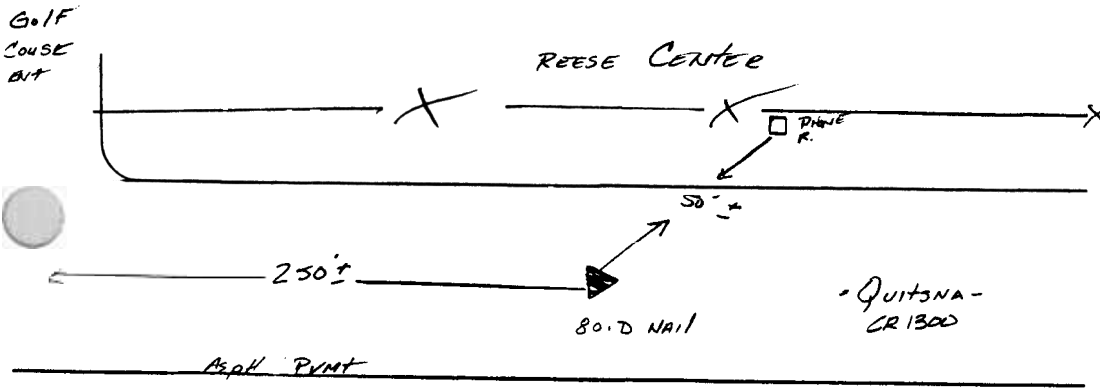

U
S
S

P
O
I
N
T

Q
U
A
D

M
A
P

N
U
M
B
E
R

W
O
L
F
F
O
R
T
H

1
0
2
6

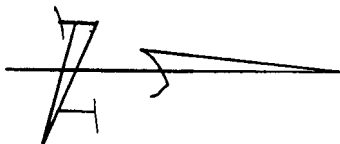

**HORIZONTAL & VERTICAL CONTROL FOR
LUBBOCK, TEXAS
JANUARY, 2000**

HORIZONTAL DATUM NAD83 VERTICAL DATUM NAVD 88

PT NO	NORTHING	EASTING	ELEVATION	WGS84 LAT	WGS84 LONG	ELLIP HGHT
1027	7280180.825	894840.429	3320.61	33°35'31.40990"N	102°01'35.27163"W	3234.57

HORIZONTAL DATUM NAD27 VERTICAL DATUM NGVD 29

PT NO	NORTHING	EASTING	ELEVATION	WGS84 LAT	WGS84 LONG	ELLIP HGHT
1027	730126.940	622156.585	3319.35	33°35'31.40990"N	102°01'35.27163"W	3234.57

POINT DESCRIPTION

80d NAIL

*wolFForth
#1027*

REVERSE CENTER

**U
S
G
S**

**P
O
I
N
T
Q
U
A
D**

**M
A
P
N
U
M
B
E
R**

**W
O
L
F
F
O
R
T
H
1
0
2
7**

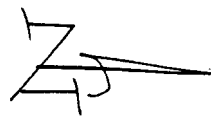
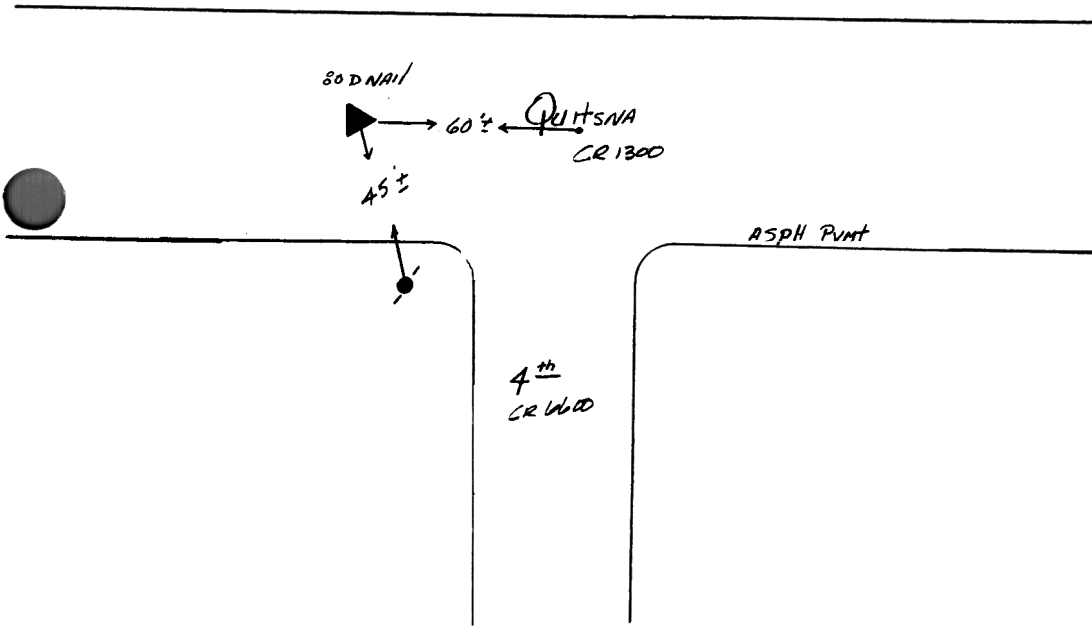

**HORIZONTAL & VERTICAL CONTROL FOR
LUBBOCK, TEXAS
JANUARY, 2000**

HORIZONTAL DATUM NAD83 VERTICAL DATUM NAVD 88

PT NO	NORTHING	EASTING	ELEVATION	WGS84 LAT	WGS84 LONG	ELLIP HGHT
1028	7282884.835	894915.796	3320.52	33°35'58.17301"N	102°01'35.45388"W	3234.44

HORIZONTAL DATUM NAD27 VERTICAL DATUM NGVD 29

PT NO	NORTHING	EASTING	ELEVATION	WGS84 LAT	WGS84 LONG	ELLIP HGHT
1028	732830.077	622257.729	3319.25	33°35'58.17301"N	102°01'35.45388"W	3234.44

POINT DESCRIPTION

80d NAIL

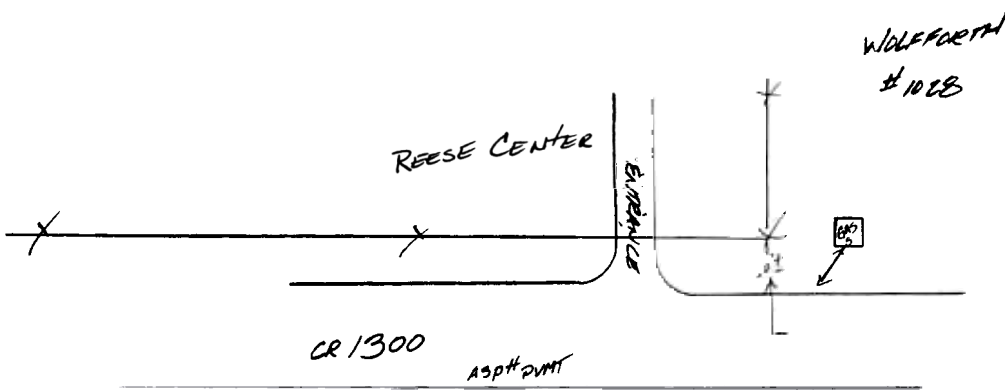

**U
S
G
S

Q
U
A
D

M
A
P

W
O
L
F
F
O
R
T
H

P
O
I
N
T

N
U
M
B
E
R

1
0
2
8**

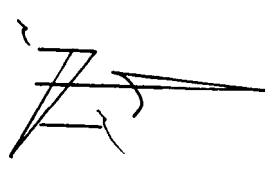

HORIZONTAL & VERTICAL CONTROL FOR LUBBOCK, TEXAS JANUARY, 2000

HORIZONTAL DATUM NAD83 VERTICAL DATUM NAVD 88

PT NO	NORTHING	EASTING	ELEVATION	WGS84 LAT	WGS84 LONG	ELLIP HGHT
1029	7286381.361	894963.565	3323.16	33°36'32.76349"N	102°01'36.27678"W	3237.01

HORIZONTAL DATUM NAD27 VERTICAL DATUM NGVD 29

PT NO	NORTHING	EASTING	ELEVATION	WGS84 LAT	WGS84 LONG	ELLIP HGHT
1029	736325.947	622338.833	3321.88	33°36'32.76349"N	102°01'36.27678"W	3237.01

POINT DESCRIPTION

80d NAIL

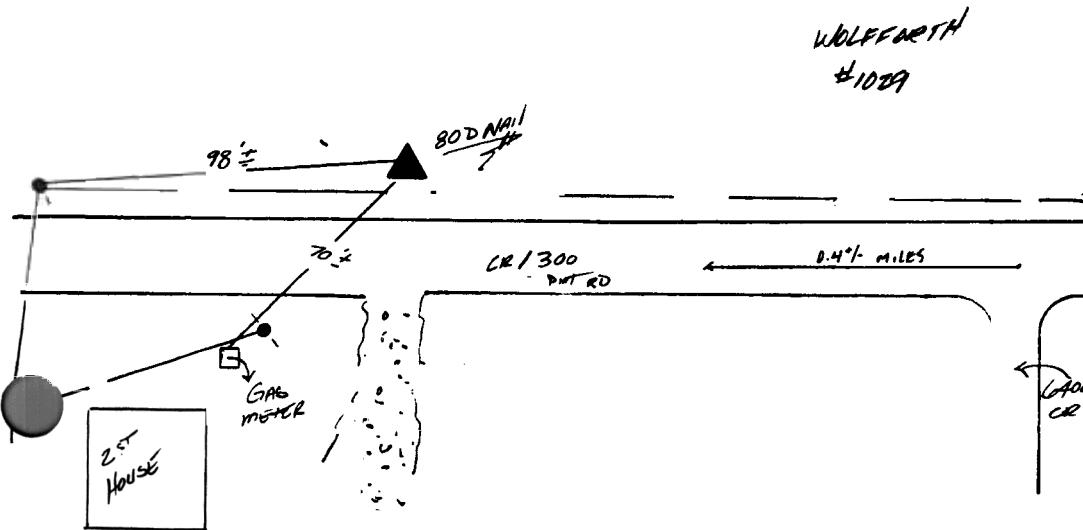

U
S
G
S

P
O
I
N
T

Q
U
A
D

M
A
P

N
U
M
B
E
R

W
O
L
F
F
O
R
T
H

1
0
2
9

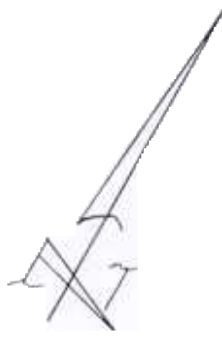

HORIZONTAL & VERTICAL CONTROL FOR LUBBOCK, TEXAS JANUARY, 2000

HORIZONTAL DATUM NAD83 VERTICAL DATUM NAVD 88

PT NO	NORTHING	EASTING	ELEVATION	WGS84 LAT	WGS84 LONG	ELLIP HGHT
1030	7288427.844	895017.954	3312.09	33°36'53.01769"N	102°01'36.44614"W	3225.90

HORIZONTAL DATUM NAD27 VERTICAL DATUM NGVD 29

PT NO	NORTHING	EASTING	ELEVATION	WGS84 LAT	WGS84 LONG	ELLIP HGHT
1030	738371.794	622412.731	3310.81	33°36'53.01769"N	102°01'36.44614"W	3225.90

POINT DESCRIPTION

80d NAIL

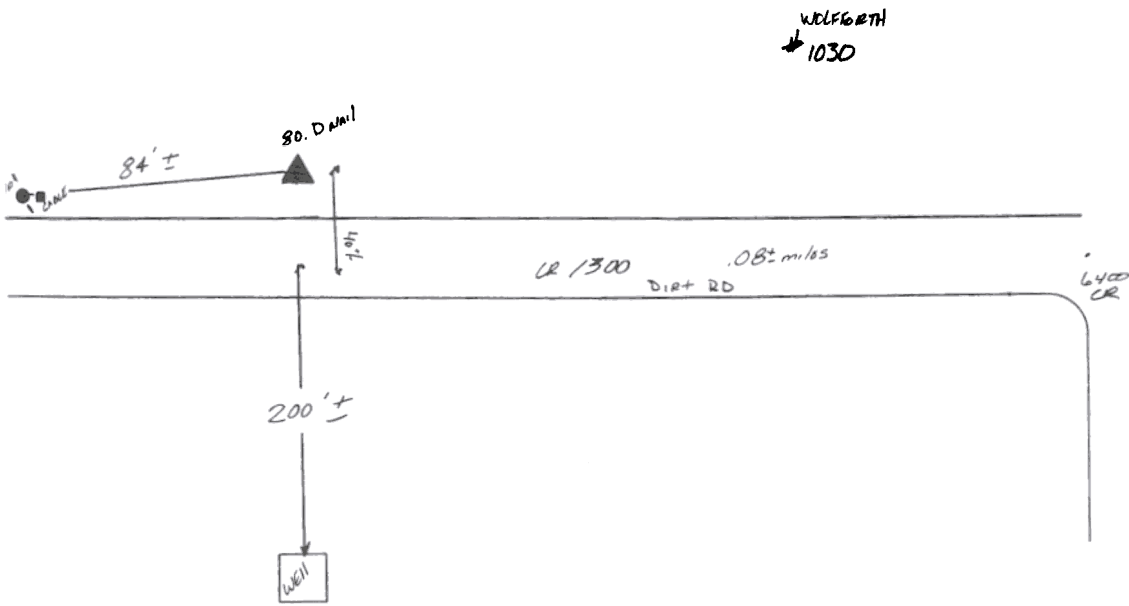

**U
S
S**

**Q
U
A
D**

**M
A
P**

**W
O
L
F
O
R
T
H**

**P
O
I
N
T**

**N
U
M
B
E
R**

**1
0
3
0**

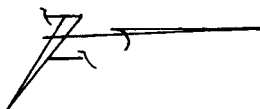

**HORIZONTAL & VERTICAL CONTROL FOR
LUBBOCK, TEXAS
JANUARY, 2000**

HORIZONTAL DATUM NAD83 VERTICAL DATUM NAVD 88

PT NO	NORTHING	EASTING	ELEVATION	WGS84 LAT	WGS84 LONG	ELLIP HGHT
1032	7290717.806	895107.852	3310.09	33°37'15.69123"N	102°01'36.29246"W	3223.86

HORIZONTAL DATUM NAD27 VERTICAL DATUM NGVD 29

PT NO	NORTHING	EASTING	ELEVATION	WGS84 LAT	WGS84 LONG	ELLIP HGHT
1032	740660.769	622524.457	3308.81	33°37'15.69123"N	102°01'36.29246"W	3223.86

POINT DESCRIPTION

80d NAIL

*WOLFFORTH
#1032*

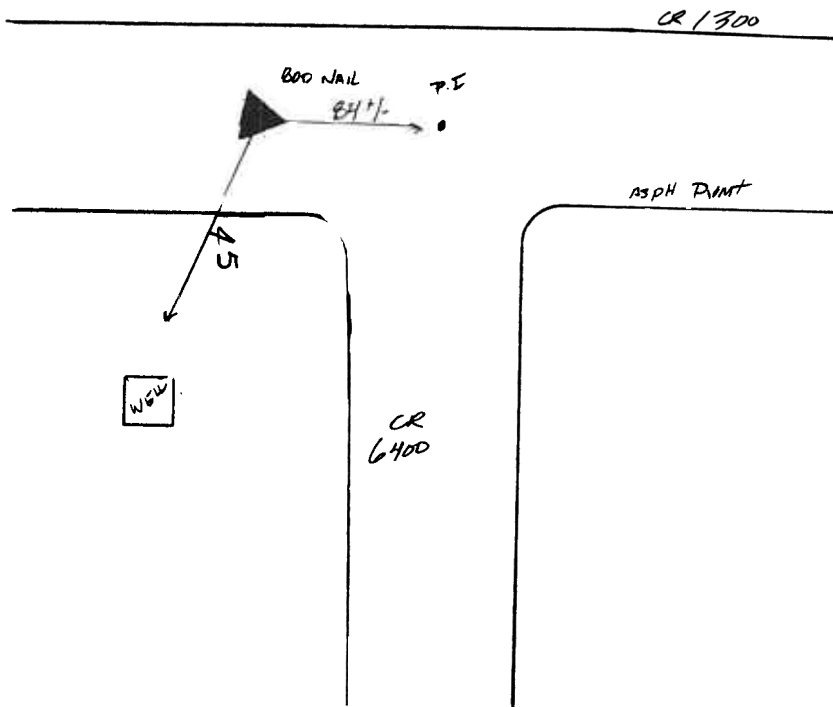

**U
S
G
S**

**Q
U
A
D**

**M
A
P**

**W
O
L
F
F
O
R
T
H**

**P
O
I
N
T

N
U
M
B
E
R

1
0
3
2**

HORIZONTAL & VERTICAL CONTROL FOR LUBBOCK, TEXAS JANUARY, 2000

HORIZONTAL DATUM NAD83 VERTICAL DATUM NAVD 88

PT NO	NORTHING	EASTING	ELEVATION	WGS84 LAT	WGS84 LONG	ELLIP HGHT
1034	7290619.957	901734.682	3298.28	33°37'16.91723"N	102°00'17.92816"W	3211.80

HORIZONTAL DATUM NAD27 VERTICAL DATUM NGVD 29

PT NO	NORTHING	EASTING	ELEVATION	WGS84 LAT	WGS84 LONG	ELLIP HGHT
1034	740499.743	629149.975	3297.00	33°37'16.91723"N	102°00'17.92816"W	3211.80

POINT DESCRIPTION

80d NAIL

Wolfforth
1034

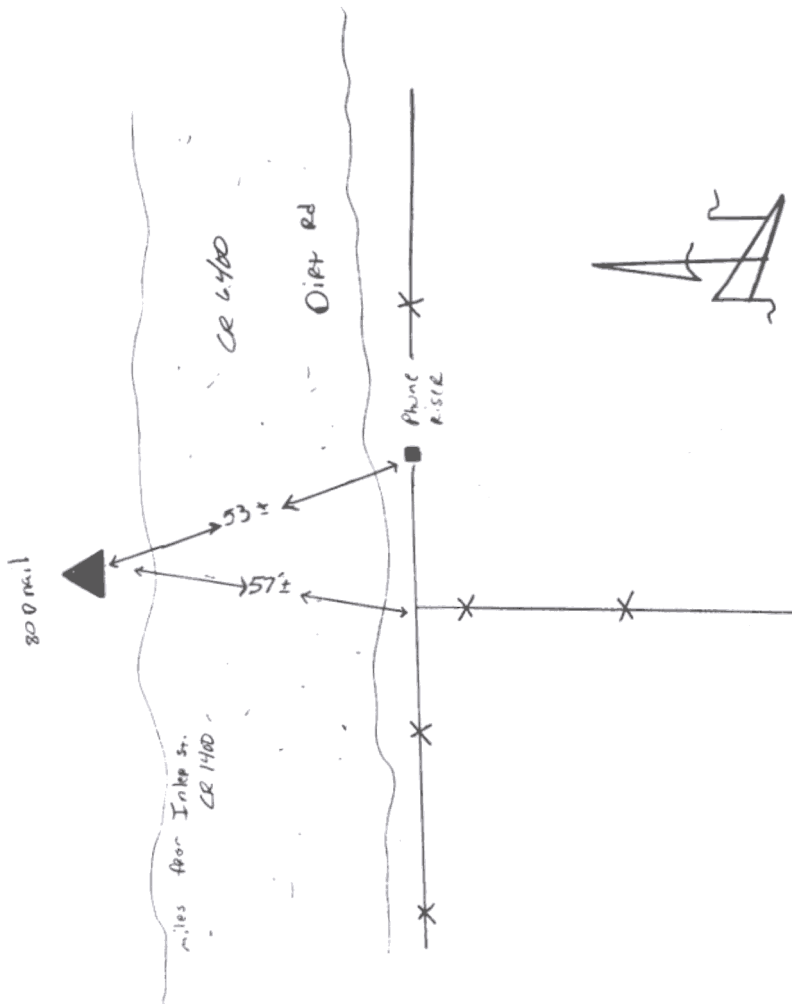

**U
S
G
S**
**Q
U
A
D**
**P
O
I
N
T**
**N
U
M
B
E
R**
**W
O
L
F
O
R
T
H**
**1
0
3
4**

**HORIZONTAL & VERTICAL CONTROL FOR
LUBBOCK, TEXAS
JANUARY, 2000**

HORIZONTAL DATUM NAD83 VERTICAL DATUM NAVD 88

PT NO	NORTHING	EASTING	ELEVATION	WGS84 LAT	WGS84 LONG	ELLIP HGHT
1035	7290625.434	900395.944	3314.45	33°37'16.52935"N	102°00'33.75356"W	3228.01

HORIZONTAL DATUM NAD27 VERTICAL DATUM NGVD 29

PT NO	NORTHING	EASTING	ELEVATION	WGS84 LAT	WGS84 LONG	ELLIP HGHT
1035	740517.983	627811.366	3313.16	33°37'16.52935"N	102°00'33.75356"W	3228.01

POINT DESCRIPTION

80d NAIL

*WolfForth
1035*

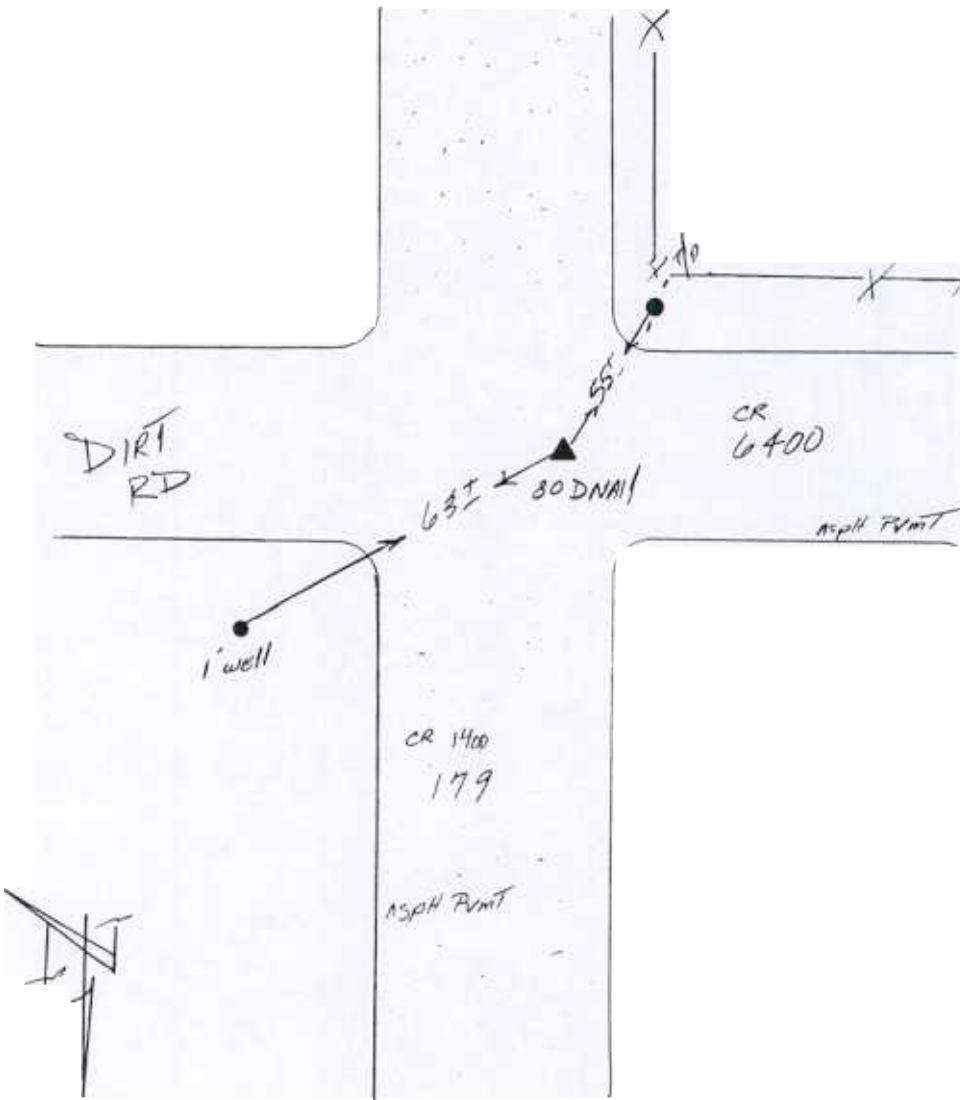

**U
S
G
S**

**Q
U
A
D**

**M
A
P
N
U
M
B
E
R**

**W
O
L
F
F
O
R
T
H
1
0
3
5**

HORIZONTAL & VERTICAL CONTROL FOR LUBBOCK, TEXAS JANUARY, 2000

HORIZONTAL DATUM NAD83 VERTICAL DATUM NAVD 88

PT NO	NORTHING	EASTING	ELEVATION	WGS84 LAT	WGS84 LONG	ELLIP HGHT
1036	7251083.949	899180.423	3316.39	33°30'45.12361"N	102°00'32.50584"W	3230.67

HORIZONTAL DATUM NAD27 VERTICAL DATUM NGVD 29

PT NO	NORTHING	EASTING	ELEVATION	WGS84 LAT	WGS84 LONG	ELLIP HGHT
1036	700990.347	626218.910	3315.18	33°30'45.12361"N	102°00'32.50584"W	3230.67

POINT DESCRIPTION

80d NAIL

*Wolfport H
#1036*

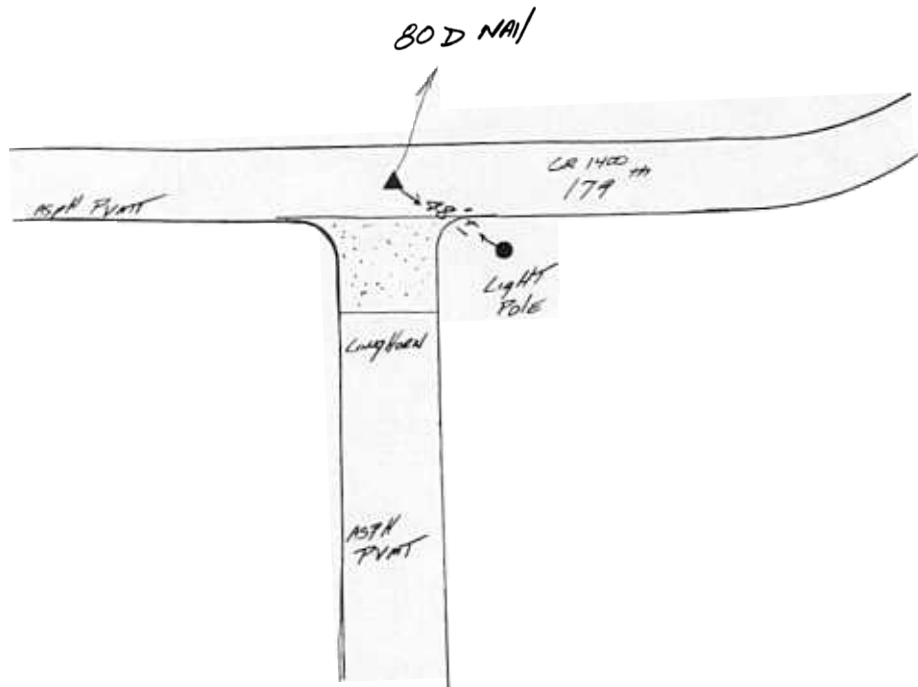

**U
S
G
S**

**P
O
I
N
T
Q
U
A
D**

**M
A
P
N
U
M
B
E
R**

**W
O
L
F
F
O
R
T
H
1
0
3
6**

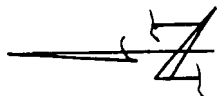

**HORIZONTAL & VERTICAL CONTROL FOR
LUBBOCK, TEXAS
JANUARY, 2000**

HORIZONTAL DATUM NAD83 VERTICAL DATUM NAVD 88

PT NO	NORTHING	EASTING	ELEVATION	WGS84 LAT	WGS84 LONG	ELLIP HGHT
1037	7253781.572	899268.079	3314.87	33°31'11.82831"N	102°00'32.53503"W	3229.11

HORIZONTAL DATUM NAD27 VERTICAL DATUM NGVD 29

PT NO	NORTHING	EASTING	ELEVATION	WGS84 LAT	WGS84 LONG	ELLIP HGHT
1037	703686.980	626332.281	3313.66	33°31'11.82831"N	102°00'32.53503"W	3229.11

POINT DESCRIPTION

80d NAIL

*Wolfforth
#1037*

**U
S
G
S

Q
U
A
D

M
A
P

W
O
L
F
F
O
R
T
H

P
O
I
N
T

N
U
M
B
E
R

1
0
3
7**

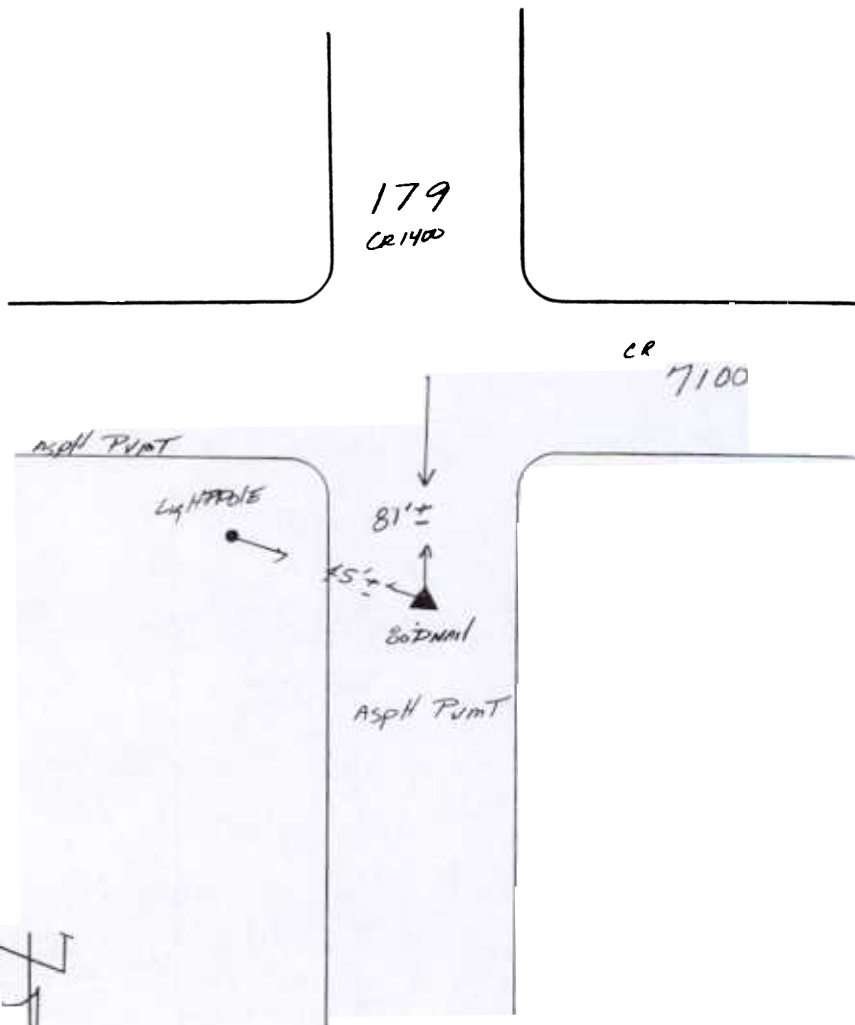

**HORIZONTAL & VERTICAL CONTROL FOR
LUBBOCK, TEXAS
JANUARY, 2000**

HORIZONTAL DATUM NAD83 VERTICAL DATUM NAVD 88

PT NO	NORTHING	EASTING	ELEVATION	WGS84 LAT	WGS84 LONG	ELLIP HGHT
1038	7256473.051	899347.913	3306.94	33°31'38.46962"N	102°00'32.65415"W	3221.13

HORIZONTAL DATUM NAD27 VERTICAL DATUM NGVD 29

PT NO	NORTHING	EASTING	ELEVATION	WGS84 LAT	WGS84 LONG	ELLIP HGHT
1038	706377.544	626437.772	3305.72	33°31'38.46962"N	102°00'32.65415"W	3221.13

POINT DESCRIPTION

80d NAIL

**U
S
G
S**

**Q
U
A
D**

**M
A
P
N
U
M
B
E
R**

**W
O
L
F
F
O
R
T
H
1
0
3
8**

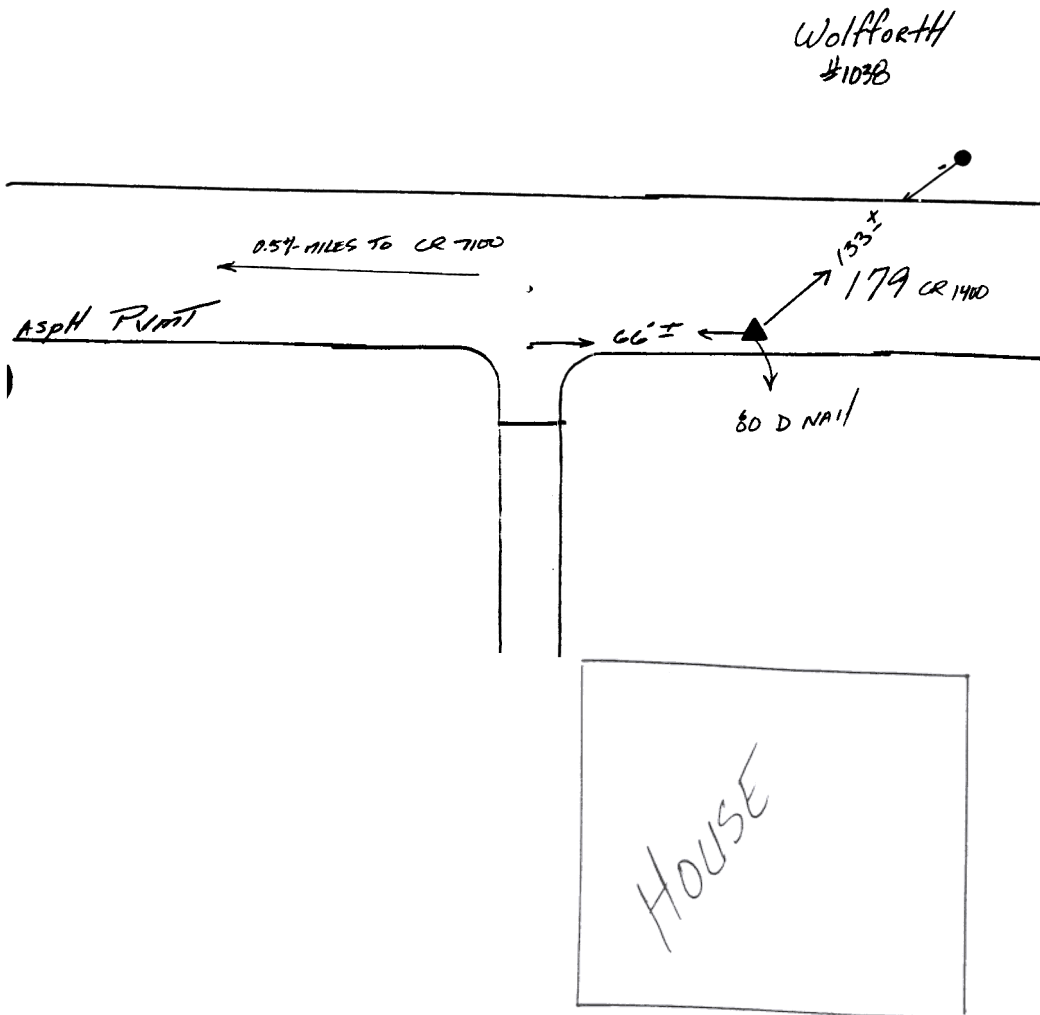

*Wolfforth
#1038*

**HORIZONTAL & VERTICAL CONTROL FOR
LUBBOCK, TEXAS
JANUARY, 2000**

HORIZONTAL DATUM NAD83 VERTICAL DATUM NAVD 88

PT NO	NORTHING	EASTING	ELEVATION	WGS84 LAT	WGS84 LONG	ELLIP HGHT
1039	7258966.549	899428.781	3297.25	33°32'03.15345"N	102°00'32.68297"W	3211.39

HORIZONTAL DATUM NAD27 VERTICAL DATUM NGVD 29

PT NO	NORTHING	EASTING	ELEVATION	WGS84 LAT	WGS84 LONG	ELLIP HGHT
1039	708870.128	626542.410	3296.03	33°32'03.15345"N	102°00'32.68297"W	3211.39

POINT DESCRIPTION

80d NAIL

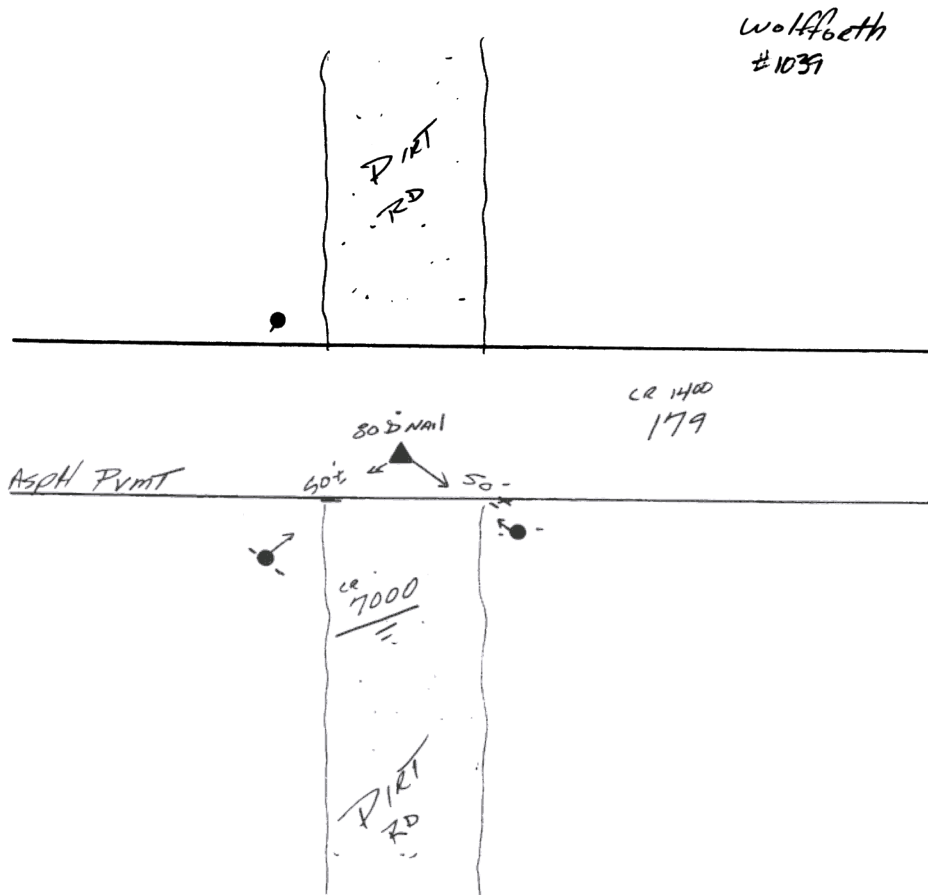

**U
S
G
S

Q
U
A
D

M
A
P

W
O
L
F
F
O
R
T
H

P
O
I
N
T

N
U
M
B
E
R

1
0
3
9**

**HORIZONTAL & VERTICAL CONTROL FOR
LUBBOCK, TEXAS
JANUARY, 2000**

HORIZONTAL DATUM NAD83 VERTICAL DATUM NAVD 88

PT NO	NORTHING	EASTING	ELEVATION	WGS84 LAT	WGS84 LONG	ELLIP HGHT
1040	7261628.097	899547.610	3299.97	33°32'29.51156"N	102°00'32.32982"W	3214.06

HORIZONTAL DATUM NAD27 VERTICAL DATUM NGVD 29

PT NO	NORTHING	EASTING	ELEVATION	WGS84 LAT	WGS84 LONG	ELLIP HGHT
1040	711530.392	626686.609	3298.74	33°32'29.51156"N	102°00'32.32982"W	3214.06

POINT DESCRIPTION

80d NAIL

*Wolfforth
#1040*

**U
S
G
S

P
O
I
N
T

Q
U
A
D**

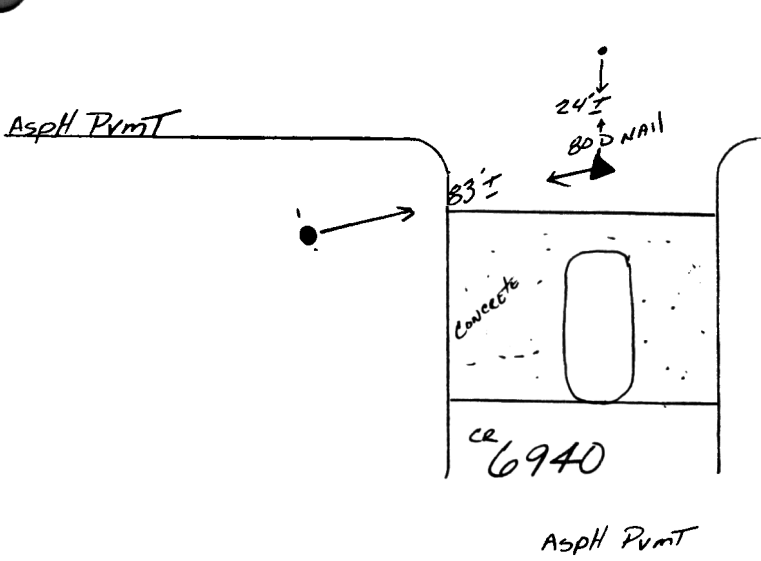

**M
A
P

N
U
M
B
E
R

W
O
L
F
F
O
R
T
H

1
0
4
0**

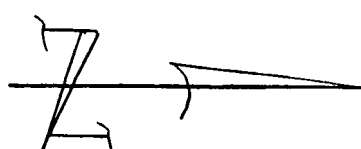

HORIZONTAL & VERTICAL CONTROL FOR LUBBOCK, TEXAS JANUARY, 2000

HORIZONTAL DATUM NAD83 VERTICAL DATUM NAVD 88

PT NO	NORTHING	EASTING	ELEVATION	WGS84 LAT	WGS84 LONG	ELLIP HGHT
1041	7264248.824	899600.561	3304.78	33°32'55.44417"N	102°00'32.73852"W	3218.83

HORIZONTAL DATUM NAD27 VERTICAL DATUM NGVD 29

PT NO	NORTHING	EASTING	ELEVATION	WGS84 LAT	WGS84 LONG	ELLIP HGHT
1041	714150.464	626764.543	3303.55	33°32'55.44417"N	102°00'32.73852"W	3218.83

POINT DESCRIPTION

80d NAIL

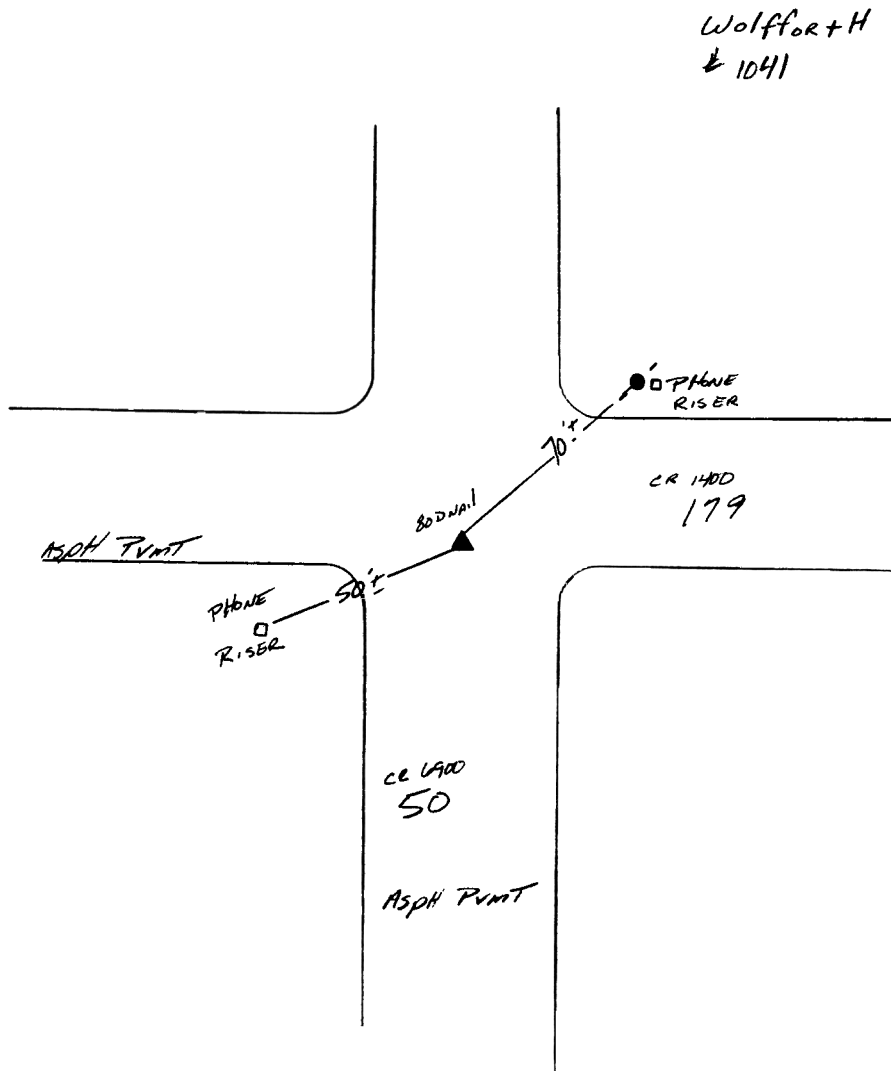

U
S
G
S

Q
U
A
D

M
A
P

W
O
L
F
F
O
R
T
H

P
O
I
N
T

N
U
M
B
E
R

1
0
4
1

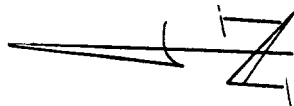

**HORIZONTAL & VERTICAL CONTROL FOR
LUBBOCK, TEXAS
JANUARY, 2000**

HORIZONTAL DATUM NAD83 VERTICAL DATUM NAVD 88

PT NO	NORTHING	EASTING	ELEVATION	WGS84 LAT	WGS84 LONG	ELLIP HGHT
1042	7266797.849	899683.839	3311.13	33°33'20.67771"N	102°00'32.76080"W	3225.13

HORIZONTAL DATUM NAD27 VERTICAL DATUM NGVD 29

PT NO	NORTHING	EASTING	ELEVATION	WGS84 LAT	WGS84 LONG	ELLIP HGHT
1042	716698.549	626872.120	3309.89	33°33'20.67771"N	102°00'32.76080"W	3225.13

POINT DESCRIPTION

80d NAIL

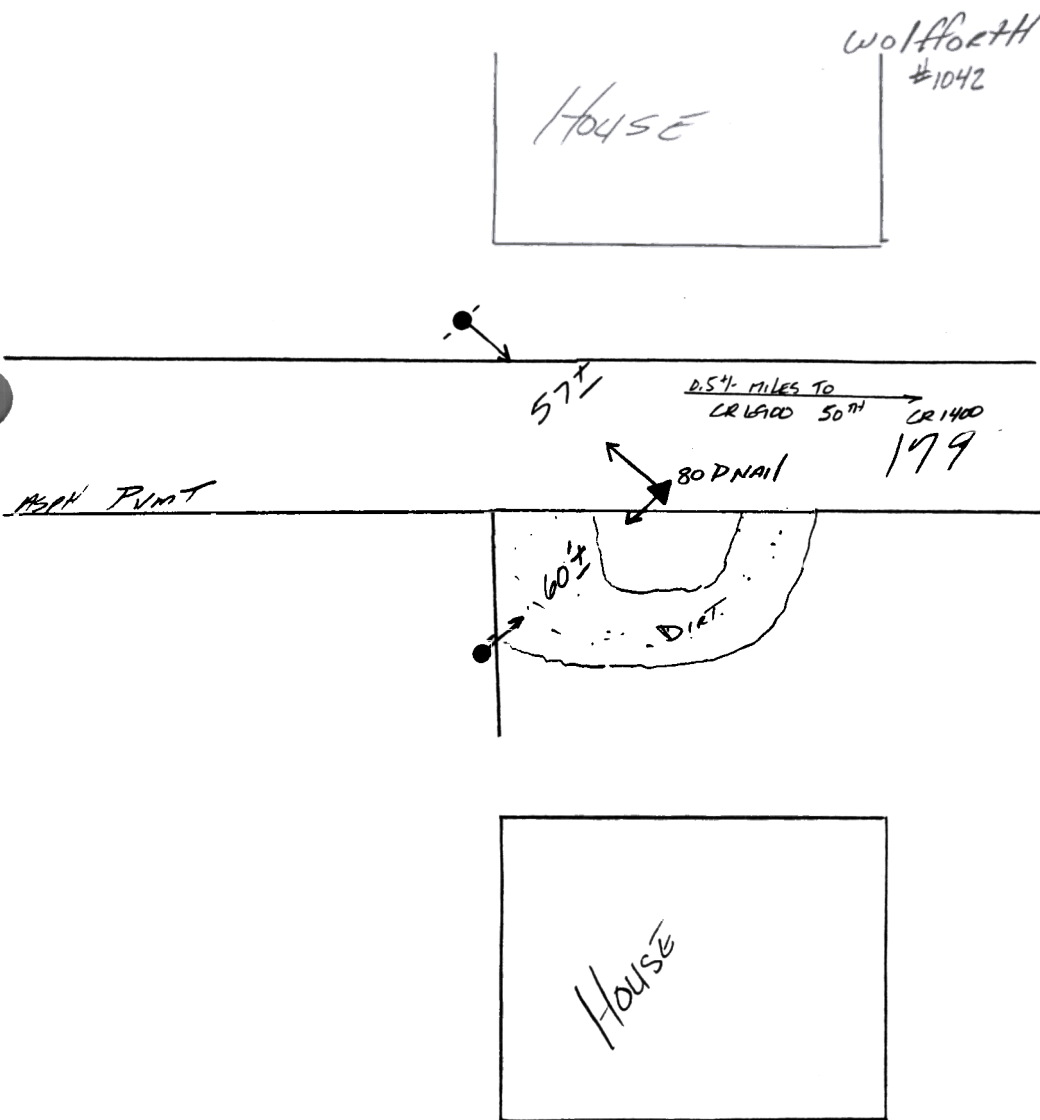

**U
S
G
S

P
O
I
N
T

Q
U
A
D

M
A
P

W
O
L
F
F
O
R
T
H

N
U
M
B
E
R

1
0
4
2**

HORIZONTAL & VERTICAL CONTROL FOR LUBBOCK, TEXAS JANUARY, 2000

HORIZONTAL DATUM NAD83 VERTICAL DATUM NAVD 88

PT NO	NORTHING	EASTING	ELEVATION	WGS84 LAT	WGS84 LONG	ELLIP HGHT
1043	7269522.814	899771.257	3317.81	33°33'47.65236"N	102°00'32.80362"W	3231.76

HORIZONTAL DATUM NAD27 VERTICAL DATUM NGVD 29

PT NO	NORTHING	EASTING	ELEVATION	WGS84 LAT	WGS84 LONG	ELLIP HGHT
1043	719422.525	626985.514	3316.57	33°33'47.65236"N	102°00'32.80362"W	3231.76

POINT DESCRIPTION

80d NAIL

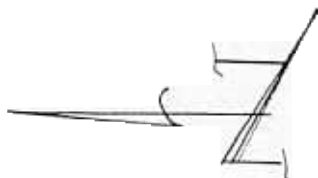
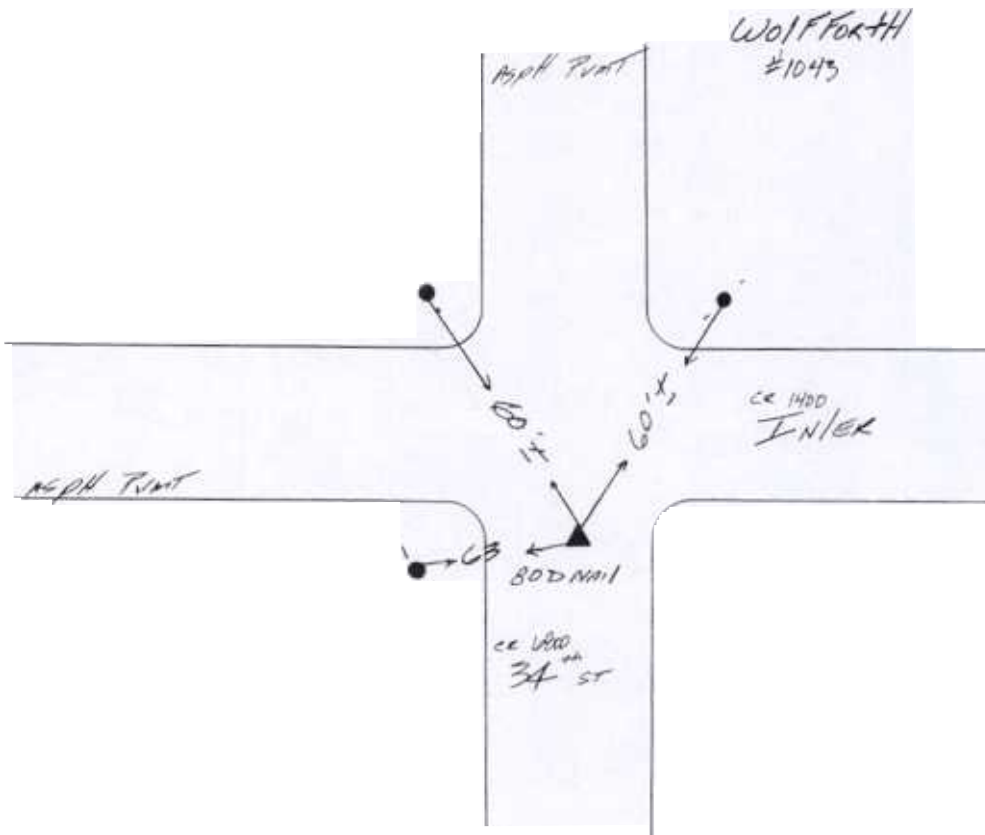

U
S
G
S

P
O
I
N
T

Q
U
A
D

M
A
P

N
U
M
B
E
R

W
O
L
F
F
O
R
T
H

1
0
4
3

**HORIZONTAL & VERTICAL CONTROL FOR
LUBBOCK, TEXAS
JANUARY, 2000**

HORIZONTAL DATUM NAD83 VERTICAL DATUM NAVD 88

PT NO	NORTHING	EASTING	ELEVATION	WGS84 LAT	WGS84 LONG	ELLIP HGHT
1044	7248413.225	899164.578	3313.43	33°30'18.70856"N	102°00'31.63963"W	3227.75

HORIZONTAL DATUM NAD27 VERTICAL DATUM NGVD 29

PT NO	NORTHING	EASTING	ELEVATION	WGS84 LAT	WGS84 LONG	ELLIP HGHT
1044	698319.927	626177.602	3312.22	33°30'18.70856"N	102°00'31.63963"W	3227.75

POINT DESCRIPTION

80d NAIL

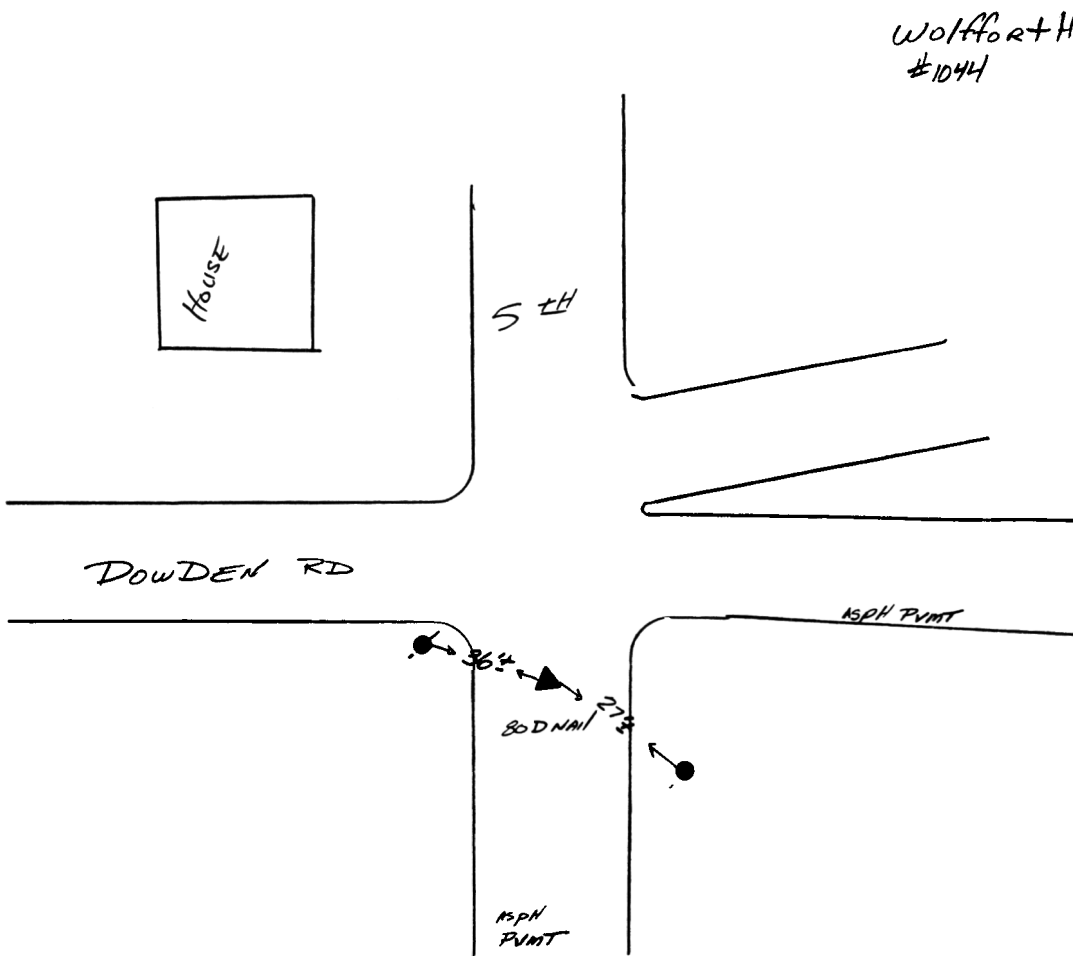

U
S
G
S

P
O
I
N
T

Q
U
A
D

M
A
P

N
U
M
B
E
R

W
O
L
F
F
O
R
T
H

1
0
4
4

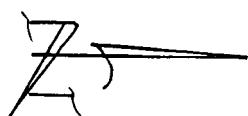

**HORIZONTAL & VERTICAL CONTROL FOR
LUBBOCK, TEXAS
JANUARY, 2000**

HORIZONTAL DATUM NAD83 VERTICAL DATUM NAVD 88

PT NO	NORTHING	EASTING	ELEVATION	WGS84 LAT	WGS84 LONG	ELLIP HGHT
1126	7272194.617	899857.646	3323.27	33°34'14.10091"N	102°00'32.83761"W	3237.17

HORIZONTAL DATUM NAD27 VERTICAL DATUM NGVD 29

PT NO	NORTHING	EASTING	ELEVATION	WGS84 LAT	WGS84 LONG	ELLIP HGHT
1126	722093.352	627097.372	3322.02	33°34'14.10091"N	102°00'32.83761"W	3237.17

POINT DESCRIPTION

80d NAIL

*Wolforth
1126*

**U
S
G
S**

**P
O
I
N
T
Q
U
A
D**

**M
A
P
N
U
M
B
E
R**

**W
O
L
F
O
R
T
H
1
1
2
6**

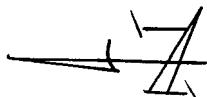
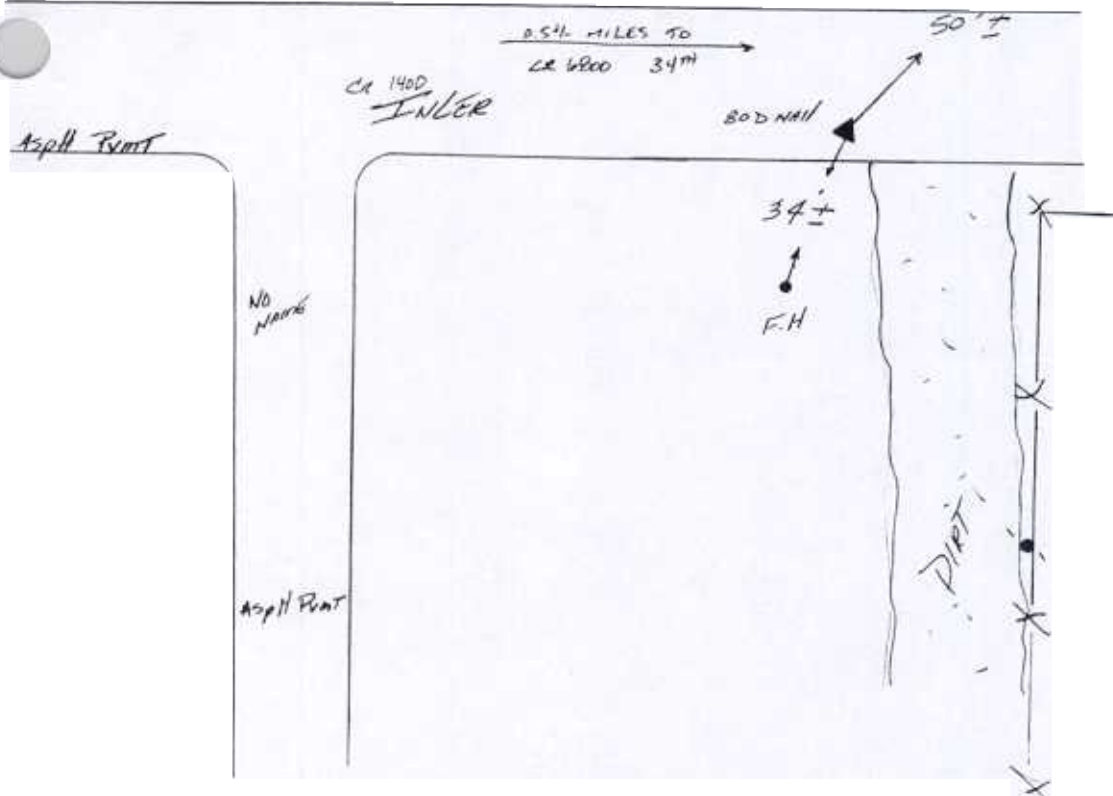

HORIZONTAL & VERTICAL CONTROL FOR LUBBOCK, TEXAS JANUARY, 2000

HORIZONTAL DATUM NAD83 VERTICAL DATUM NAVD 88

PT NO	NORTHING	EASTING	ELEVATION	WGS84 LAT	WGS84 LONG	ELLIP HGHT
1127	7274919.710	899943.282	3317.88	33°34'41.07610"N	102°00'32.90155"W	3231.73

HORIZONTAL DATUM NAD27 VERTICAL DATUM NGVD 29

PT NO	NORTHING	EASTING	ELEVATION	WGS84 LAT	WGS84 LONG	ELLIP HGHT
1127	724817.473	627208.985	3316.62	33°34'41.07610"N	102°00'32.90155"W	3231.73

POINT DESCRIPTION

80d NAIL

**U
S
G
S**

**P
O
I
N
T
Q
U
A
D**

**M
A
P
N
U
M
B
E
R**

**W
O
L
F
F
O
R
T
H
1
1
2
7**

*Wolf Forth
#1127*

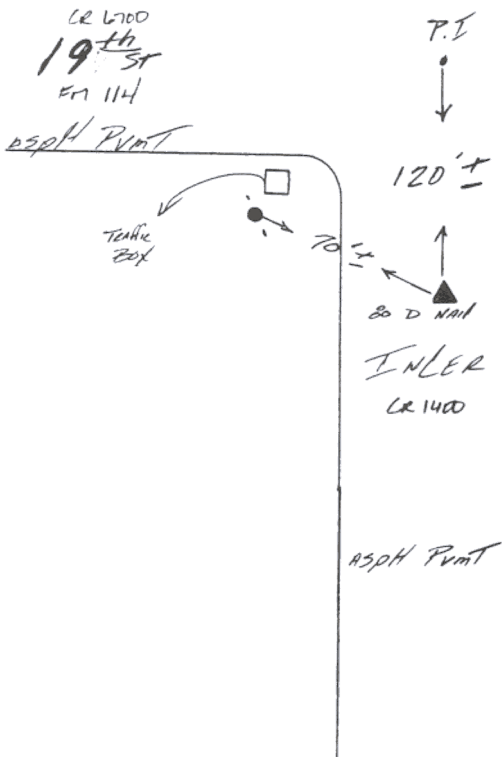

**HORIZONTAL & VERTICAL CONTROL FOR
LUBBOCK, TEXAS
JANUARY, 2000**

HORIZONTAL DATUM NAD83 VERTICAL DATUM NAVD 88

PT NO	NORTHING	EASTING	ELEVATION	WGS84 LAT	WGS84 LONG	ELLIP HGHT
1128	7277641.736	900027.933	3320.09	33°35'08.02057"N	102°00'32.97592"W	3233.89

HORIZONTAL DATUM NAD27 VERTICAL DATUM NGVD 29

PT NO	NORTHING	EASTING	ELEVATION	WGS84 LAT	WGS84 LONG	ELLIP HGHT
1128	727538.536	627319.585	3318.83	33°35'08.02057"N	102°00'32.97592"W	3233.89

POINT DESCRIPTION

80d NAIL

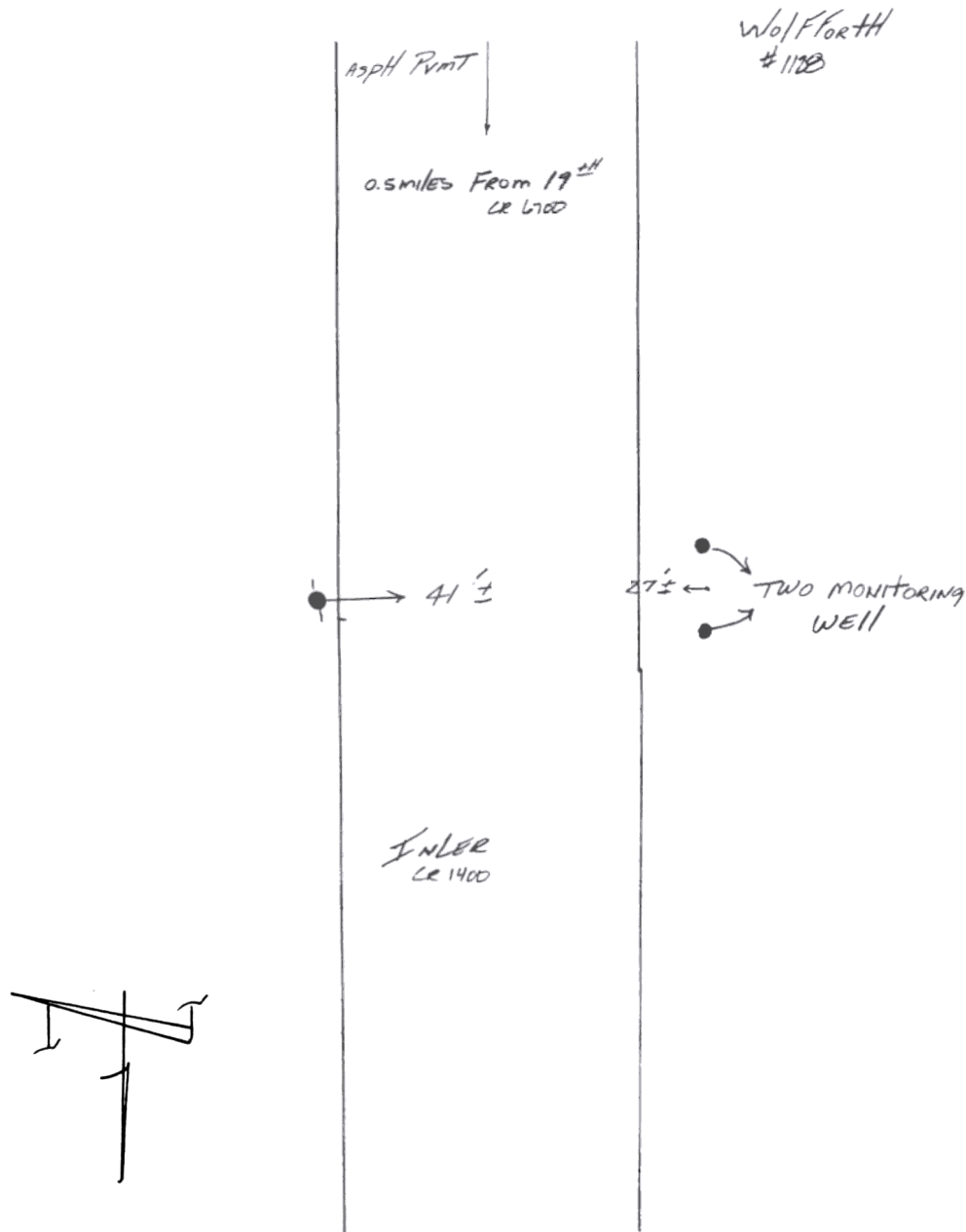

**U
S
G
S**

**Q
U
A
D**

**M
A
P**

**W
O
L
F
F
O
R
T
H**

**P
O
I
N
T**

**N
U
M
B
E
R**

**1
1
2
8**

HORIZONTAL & VERTICAL CONTROL FOR LUBBOCK, TEXAS JANUARY, 2000

HORIZONTAL DATUM NAD83 VERTICAL DATUM NAVD 88

PT NO	NORTHING	EASTING	ELEVATION	WGS84 LAT	WGS84 LONG	ELLIP HGHT
1129	7280208.758	900122.213	3320.49	33°35'33.43542"N	102°00'32.87534"W	3234.24

HORIZONTAL DATUM NAD27 VERTICAL DATUM NGVD 29

PT NO	NORTHING	EASTING	ELEVATION	WGS84 LAT	WGS84 LONG	ELLIP HGHT
1129	730104.512	627438.334	3319.22	33°35'33.43542"N	102°00'32.87534"W	3234.24

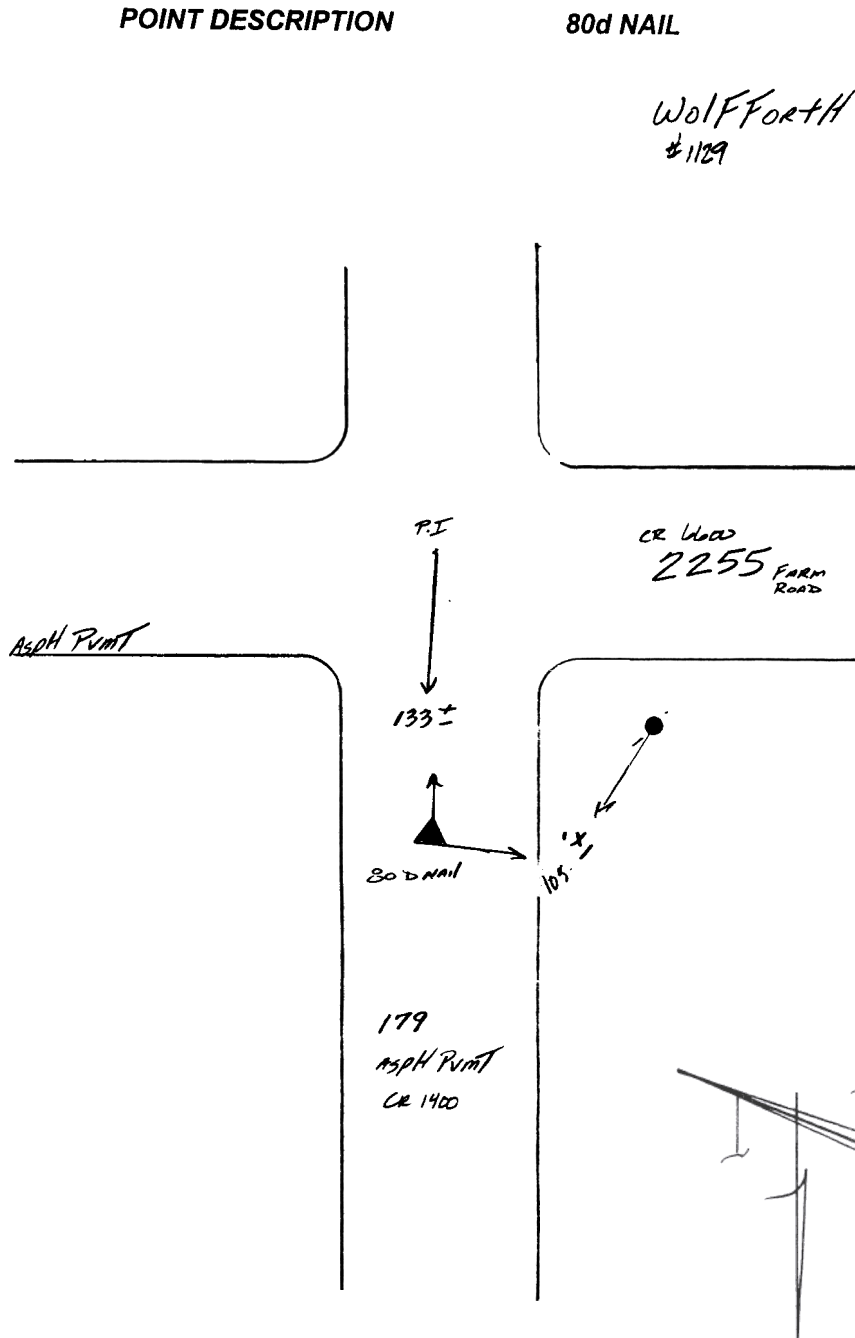

U
S
G
S

 Q
U
A
D

 M
A
P

 W
O
L
F
F
O
R
T
H

 N
U
M
B
E
R

 1
1
2
9

PT NO	NORTHING	EASTING	ELEVATION	WGS84 LAT	WGS84 LONG	ELLIP HGHT
1130	7283022.455	900189.744	3327.74	33°36'01.28058"N	102°00'33.18822"W	3241.44

HORIZONTAL DATUM NAD27 VERTICAL DATUM NGVD 29

PT NO	NORTHING	EASTING	ELEVATION	WGS84 LAT	WGS84 LONG	ELLIP HGHT
1130	732917.405	627532.688	3326.47	33°36'01.28058"N	102°00'33.18822"W	3241.44

POINT DESCRIPTION

80d NAIL

*WOLFORTH
#1130*

*0.5 miles from 2255 Farm
CR 1400*

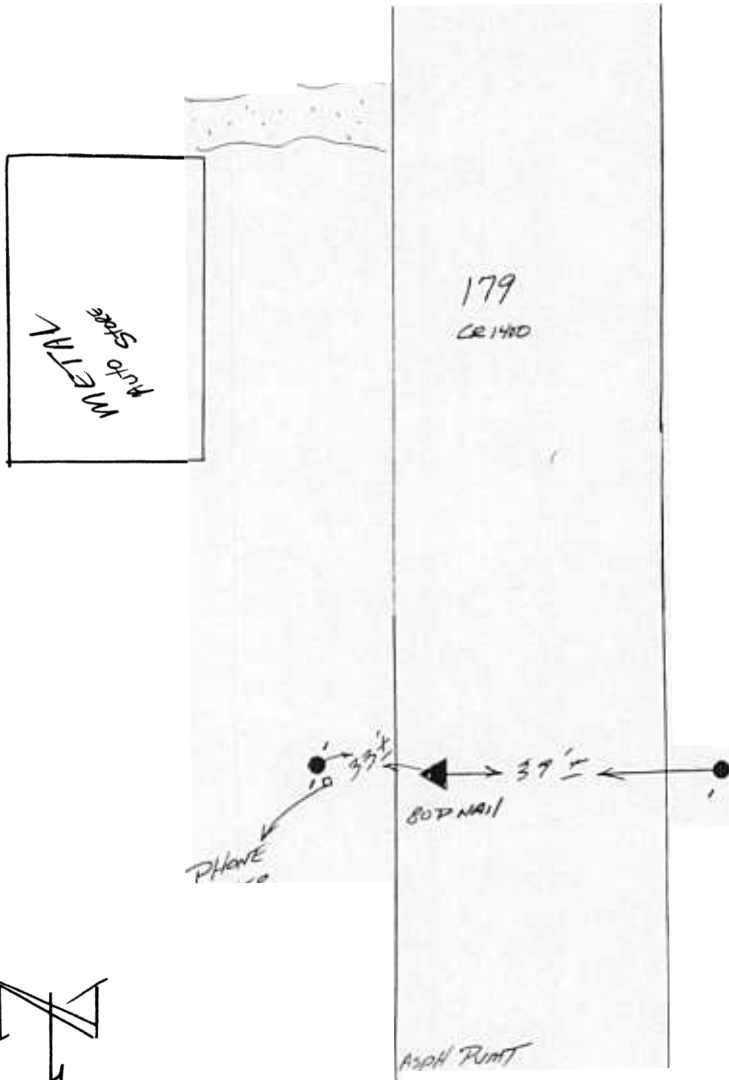

**U
S
S

Q
U
A
D

M
A
P

W
O
L
F
F
O
R
T
H**

**P
O
I
N
T

N
U
M
B
E
R

1
1
3
0**



HORIZONTAL & VERTICAL CONTROL FOR LUBBOCK, TEXAS JANUARY, 2000

HORIZONTAL DATUM NAD83 VERTICAL DATUM NAVD 88

PT NO	NORTHING	EASTING	ELEVATION	WGS84 LAT	WGS84 LONG	ELLIP HGHT
1131	7285375.781	900259.553	3329.18	33°36'24.57413"N	102°00'33.29245"W	3242.84

HORIZONTAL DATUM NAD27 VERTICAL DATUM NGVD 29

PT NO	NORTHING	EASTING	ELEVATION	WGS84 LAT	WGS84 LONG	ELLIP HGHT
1131	735269.931	627624.931	3327.91	33°36'24.57413"N	102°00'33.29245"W	3242.84

POINT DESCRIPTION

80d NAIL

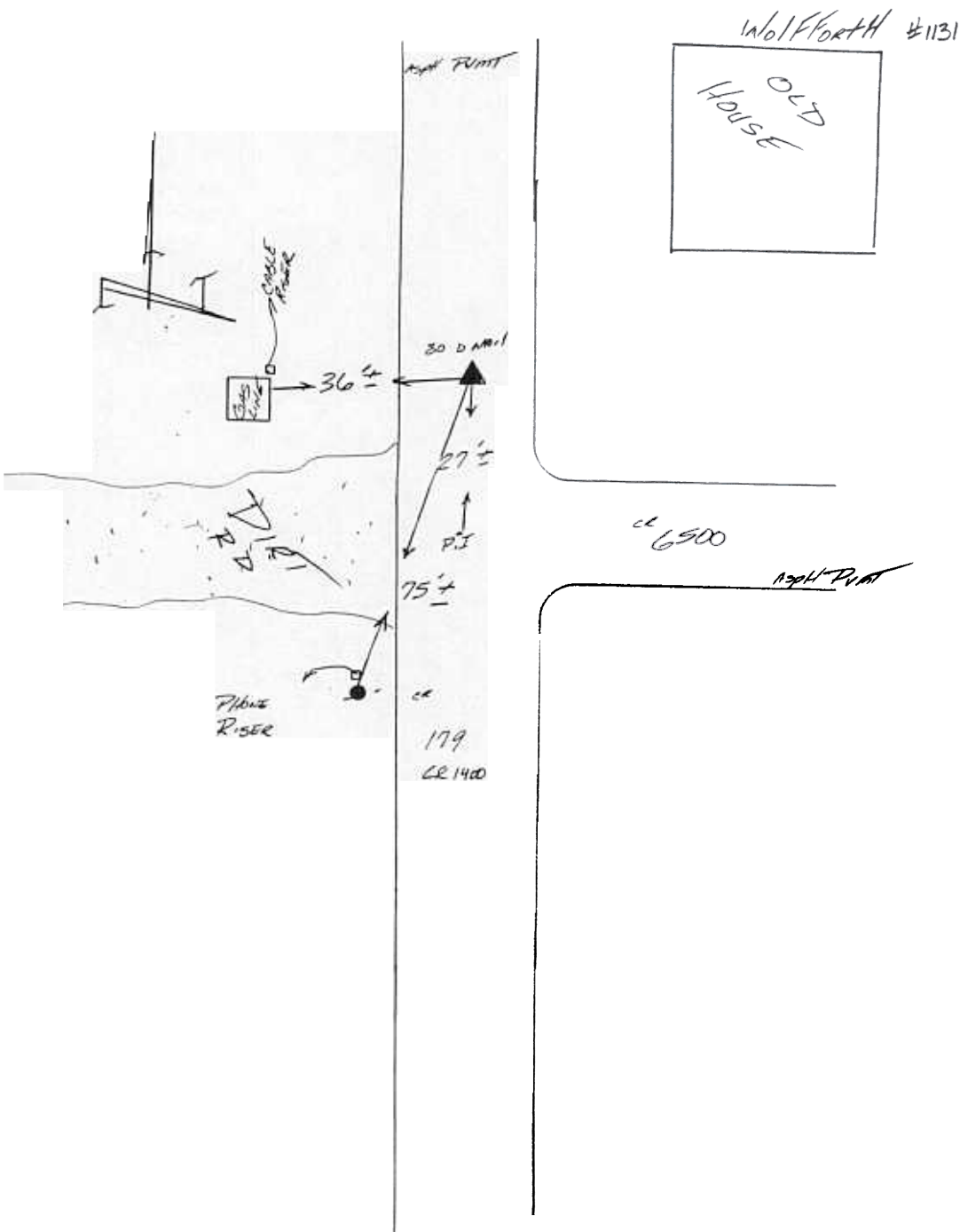

U
S
G
S

Q
U
A
D

M
A
P

W
O
L
F
F
O
R
T
H

P
O
I
N
T

N
U
M
B
E
R

1
1
3
1

HORIZONTAL & VERTICAL CONTROL FOR LUBBOCK, TEXAS JANUARY, 2000

HORIZONTAL DATUM NAD83 VERTICAL DATUM NAVD 88

PT NO	NORTHING	EASTING	ELEVATION	WGS84 LAT	WGS84 LONG	ELLIP HGHT
1132	7288219.623	900333.912	3320.78	33°36'52.71950"N	102°00'33.53663"W	3234.38

HORIZONTAL DATUM NAD27 VERTICAL DATUM NGVD 29

PT NO	NORTHING	EASTING	ELEVATION	WGS84 LAT	WGS84 LONG	ELLIP HGHT
1132	738112.901	627726.400	3319.50	33°36'52.71950"N	102°00'33.53663"W	3234.38

POINT DESCRIPTION

80d NAIL

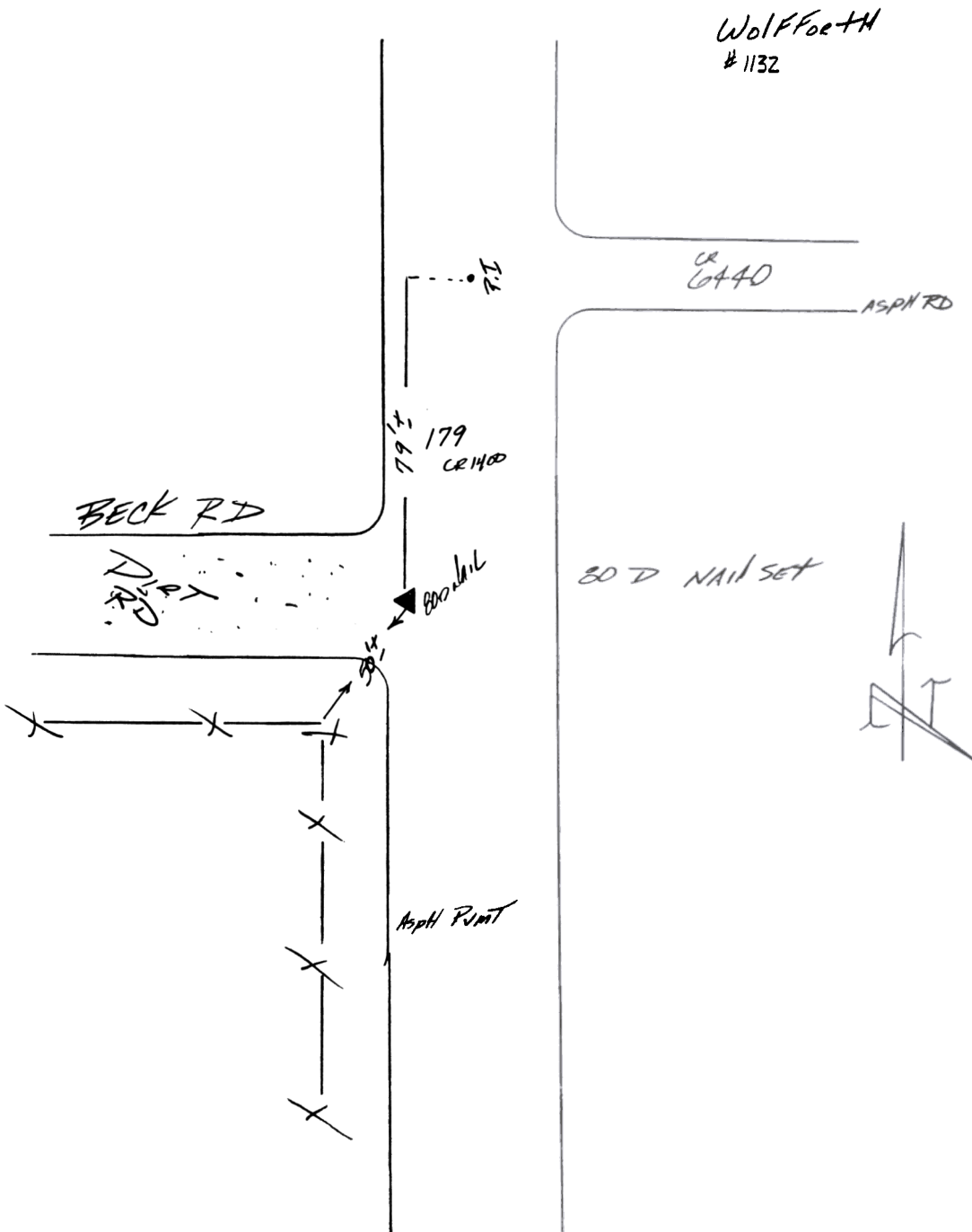

**U
S
S
Q
U
A
D

M
A
P

W
O
L
F
F
O
R
T
H**

**P
O
I
N
T

N
U
M
B
E
R

1
1
3
2**